

ELOK

6-Series User Manual



Summary Check List:

For further details see pages 7-11

1. Crop out done as per template.

2. Check rubber gasket installed correctly with lugs pressed in tight. So proper seal around backplate edge is created.



3. Ensure sprung pin is installed, securing spindle to the spindle hub.

4. Ensure screw casing bolts and through bolts tightened.

5. Ensure power cable wire installed correctly and not bent or crimped in door.

6. Check batteries installed in correct position.

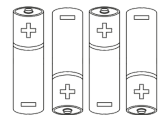

Professionally Installed by: _____

PIN-Code: _____

Date: ___/___/___

Please Note:

- Keep the included mechanical keys in a convenient place such as an Elements Hardware 1236 Key Safe.
- Replace the batteries when they have low voltage.
- Read this User Manual carefully before installing your 6-Series Smart Lock.
- **Use Alkaline 1.5v Batteries Only**



1236-BLK Shown:

Contents Page:

- Pg 5.** 6-Series Body Dimensions
- Pg 6.** 6-Series Latch
- Pg 7.** 6-Series Packing List
- Pg 8.** 6-Series Specifications
- Pg 9.** Adjusting the Handing
- Pg 10.** Installation: Steps 1-5
- Pg 11.** Installation: Steps 6-7
- Pg 12.** Factory Reset: If you're admin
- Pg 13.** Factory Reset: other methods
- Pg 14.** First Set-Up
- Pg 15.** Bluetooth Unlock + PIN Code Management
- Pg 16.** RFID Card Management + Vague Code
- Pg 17.** Remote Unlock + e-Key Management
- Pg 18.** Admin Passcode + Unlock Records
- Pg 19.** Battery Percentage + Lockset Clock
- Pg 20.** Passage Mode
- Pg 21.** Passage Mode + Remote
- Pg 22.** Extra lock settings 1
- Pg 23.** Extra lock settings 2
- Pg 24.** Extra lock settings 3
- Pg 25.** Transferring Ownership
- Pg 26.** Unlock with Mechanical Key
- Pg 27.** E-LOK Gateway Pg. 1
- Pg 28.** E-LOK Gateway Pg. 2
- Pg 29.** E-LOK Gateway Pg. 3
- Pg 30.** E-LOK Gateway additional notes
- Pg 31.** Maintenance Guide
- Pg 32.** Important Notes
- Pg 33.** Contact

6-Series Body Dimensions:

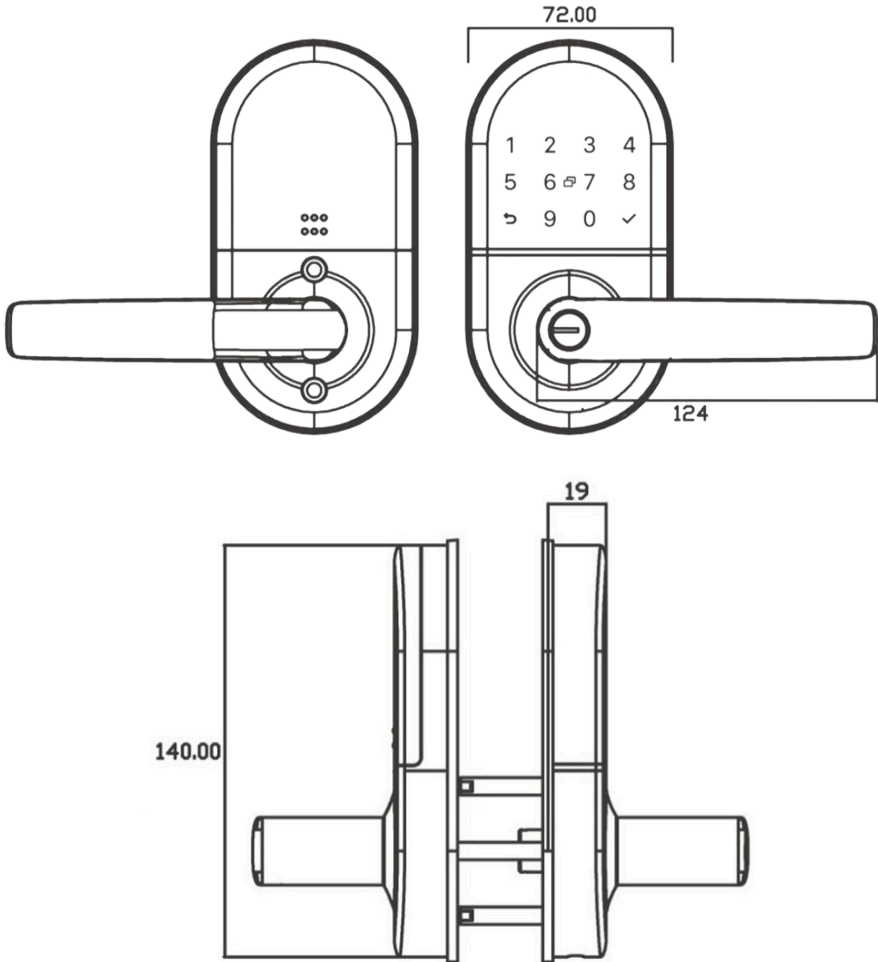

- Top, E-LOK 605 body and lever dimension
 - Bottom, side view body and lever projection
- All measurements in millimeters

Latch Options:

Back set:

Adjustable 60mm-70mm Backset

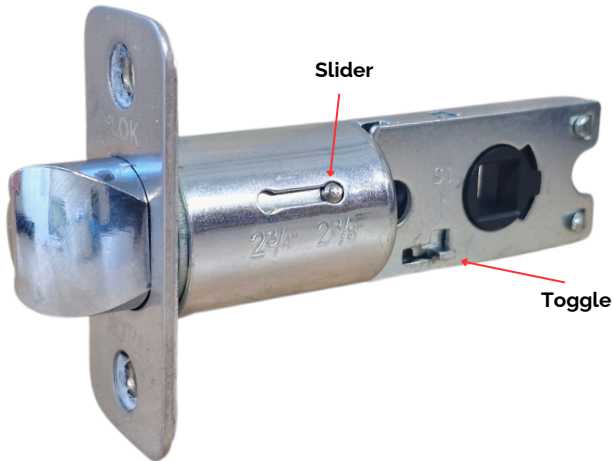

Adjustable backset to 60mm or 70mm to fit the most common size doors in New Zealand. To change to 70mm Backset, hold the toggle up while sliding the slider to the left the whole way across.

This latch opens when the handle is pulled down, or pushed up, when the E-LOK is unlocked. This is because the spindle engages with the E-LOK when the E-LOK is unlocked, meaning it can be opened.

When the E-LOK is locked, the spindle disengages with the E-LOK, so it can not be opened.

Note: Please ensure the slider is at exactly 60mm or 70mm, and not in between.

6-Series Packing List:

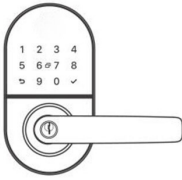

Front Panel
QTY 1

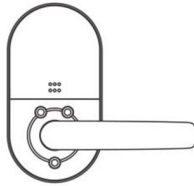

Back Panel
QTY 1

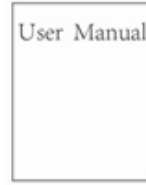

User Manual
QTY 1

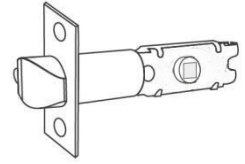

605 Latch
QTY 1

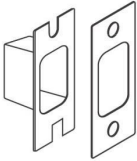

Strike & Strike Box
QTY 2



RFID Card
QTY 3



Mechanical Key
QTY 2



Gasket
QTY 2



Spindle (2 Sizes)
QTY 2

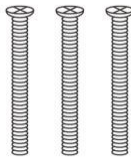

Screw A (2 Sizes)
QTY 6



Allen Wrench
QTY 1

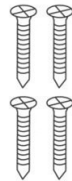

Wood Screws
QTY 4

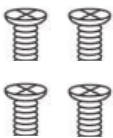

Alum Screws
QTY 4

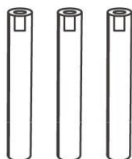

Screw Casing (2 Sizes)
QTY 6

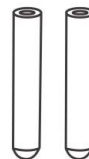

Column
QTY 2



Reset Pin
QTY 1

Specifications:

Product Name:	E-LOK 6-Series Smart Lock
Operating Application:	E-LOK App
Finish:	Black or Silver
Unlock Methods:	PIN Code RFID Card E-LOK App Mechanical Key
Max Num. Locks on App:	Unlimited
Max Num. PIN Codes:	150 PIN Codes
Max Num. RFID Cards:	200 RFID Cards
Batteries:	6V (4 x 1.5v AA Batteries) - Must be Alkaline
Operating Temp:	- 10°C - 55°C
Operating Humidity:	0% - 95%
Suitable Door Thickness:	35mm - 65mm
Suitable Door Types:	Aluminium Door, Wooden Door
Product Size (Body only):	140mm(H) x72mm(W) x19mm(D)
Product Size (Lever):	124mm(L)
Available Latch Sizes:	60mm and 70mm Back Set
6-Series Residential Warranty:	2 Year Mechanical and Electrical
E-LOK Gateway Warranty:	2 Year
Weather Rating:	Exterior Rated IP 55

Adjusting The Handing:

Steps to change the handing on E-LOK 6-Series:

Note: Adjust the handle according to the direction you open the door.

For Exterior Assembly:

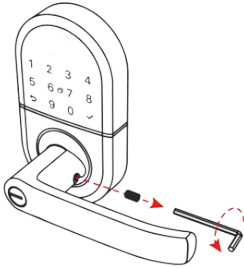

1. Loosen the screw with the 3mm Allen Wrench

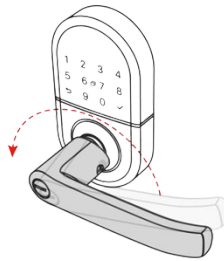

2. Adjust the door handle direction

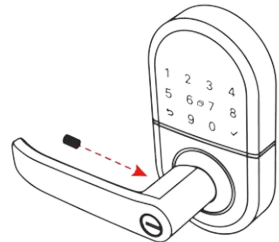

3. Tighten the screw after adjusting the handle direction.

For Interior Assembly:

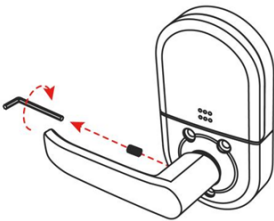

1. Loosen the screw

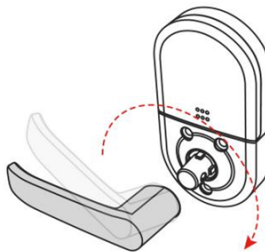

2. Lift off door handle, and adjust the door handle direction

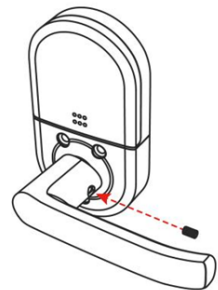

3. Tighten the screw after adjusting the handle direction.

Installation:

Step 1.

If you are retrofitting into an existing 54mm hole, this step may not be required. If you are fitting the 6-Series into a new hole, begin to cut the precise holes into your door/frame for the Hardware, and the Strike. Follow the template included. Your E-LOK 6-Series comes with screws to suit both wooden and aluminum doors. Insert latch and screw in, then install the strike/strike box.

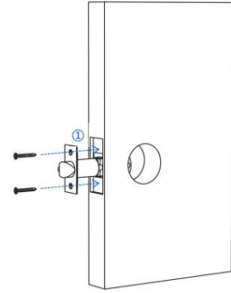

Step 2.

Install the Gasket on the exterior panel.

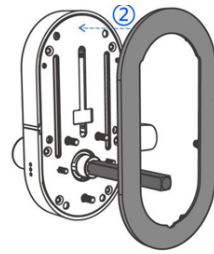

Step 3.

Install spindle into spindle hub. Ensure sprung pin is seated correctly to hold spindle to spindle hub. (See step 3 for image)

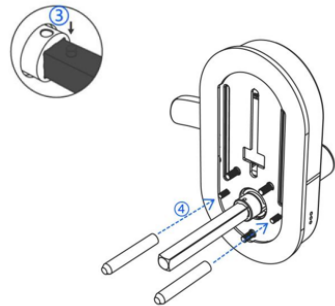

Step 4.

Install 2 positioning columns.

Step 5.

Install 3 screw casings (choose size depending on door thickness), and place exterior panel on the door.

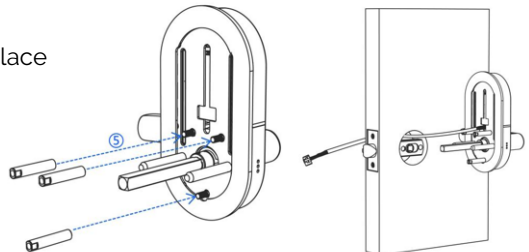

Installation:

Step 6.

Install gasket on interior panel and connect exterior wire to interior, and screw interior panel to exterior panel with screw A (choose size depending on door thickness).

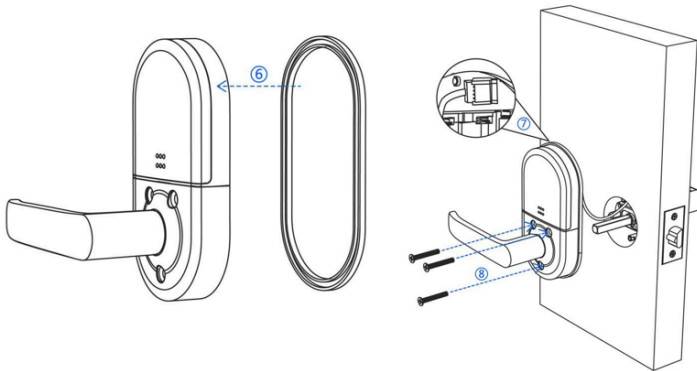

Step 7.

Now you are ready to install 4 x AA Alkaline batteries.

Install the batteries making sure they are sitting correctly, and are installed the right way up.

Install battery cover.

Now your E-LOK 6-Series Smart Lock is ready to set up.

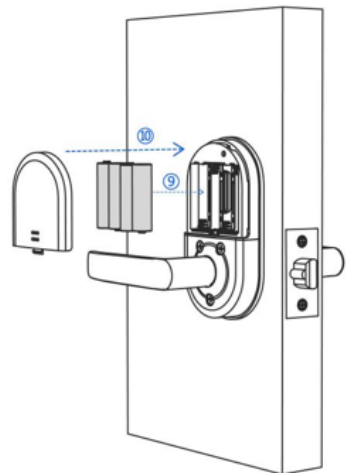

Factory Reset: (if you are admin and in Bluetooth range)

Normal Factory Reset:

You must be admin and in Bluetooth range of the Smart lock in order to complete factory reset.

You can factory reset your E-LOK by going into the lock settings and tapping "Delete".

This will fully factory reset the E-LOK Smart Lock.

From here you can re-setup the Smart Lock as required.

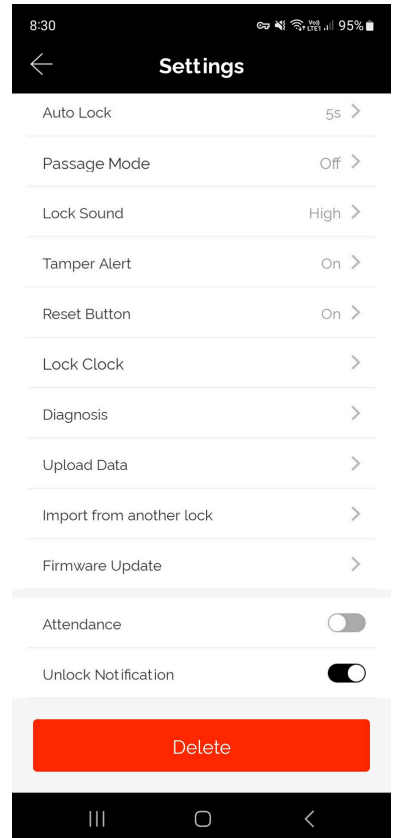

Manual Factory Reset

Manual reset:

If you are not admin of the E-LOK Smart Lock, or you wish to perform a manual factory reset, remove battery cover and complete:

Long press the button on the top right side in battery case using reset pin, for 5 seconds or until you hear "Please Input Initialization Passcode". Now input code "000✓" on the keypad.

The system reset will be complete. From here you can link the E-LOK Smart Lock to your phone.



Please Note: The default code before connecting to the E-LOK, is **123456✓**.

Trouble shooting:

If you performed a manual reset whilst you were admin of the E-LOK, transferring Lockset to Trash will complete the reset of the E-LOK:

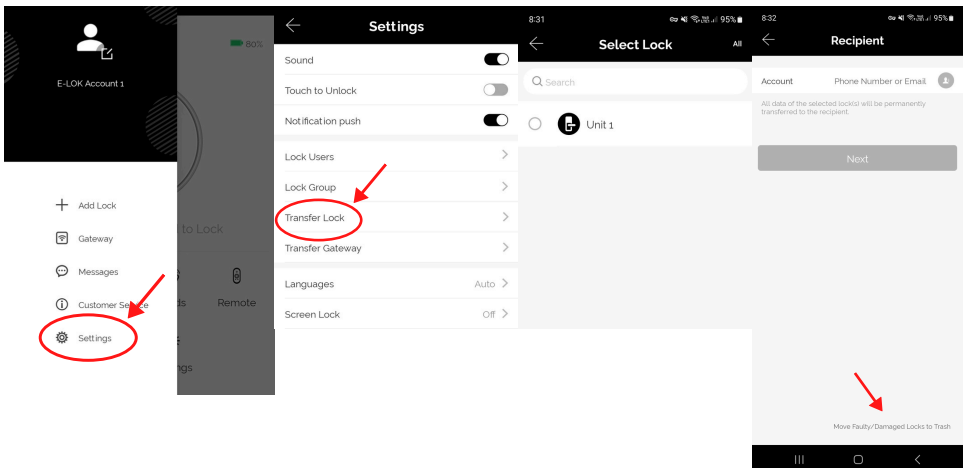

First Set-Up:

Get the E-LOK App by visiting E-LOK.com for the app download link

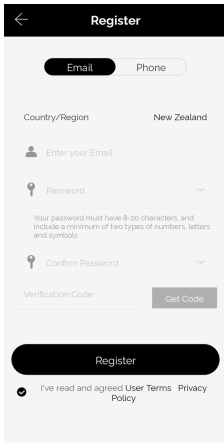

1. Register an account with E-LOK using either phone number or email.

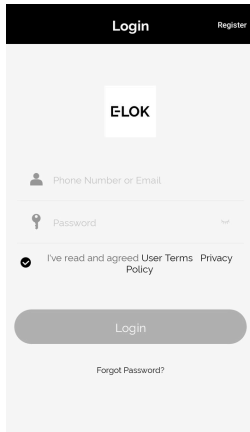

2. Login to your account.

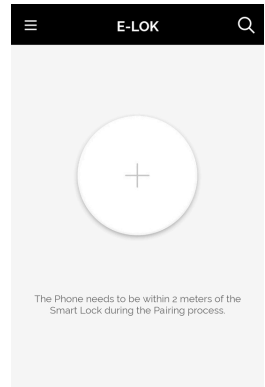

3. Ensure E-LOK 6-Series is on and Bluetooth enabled on phone. To connect to lock the lock, tap pinpad & + sign to pair.

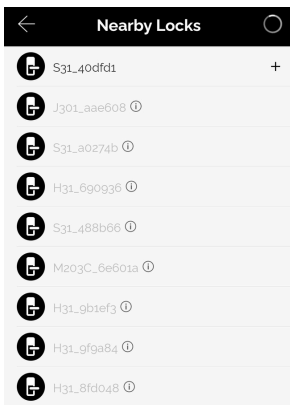

4. Select your E-LOK 6-Series. Note it will not be called the model of your E-LOK Smart Lock. It is usually the one at the very top in a black font

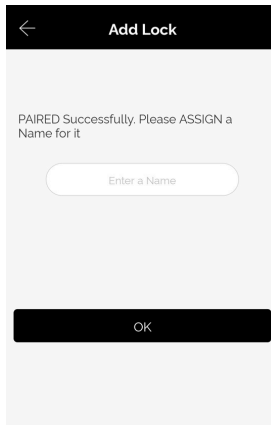

5. Rename your E-LOK 6-Series to your preference.

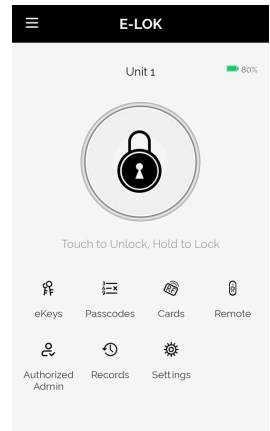

6. View your E-LOK lock management page.

Bluetooth Unlock + PIN Code Management

Bluetooth Unlock:

After you've connected your phone to your E-LOK Smart Lock, open the lock management page and tap the "Unlock" icon. This will unlock your Smart Lock via Bluetooth and it will automatically re-lock itself according to the set auto lock timer.



PIN code Management:

E-LOK App allows you to set 150 unique PIN Codes on the 6-Series. You can set a range of different types of PIN Code. The best is to choose 'Custom' to create yours. Set it to permanent, name it and set your preferred sequence. (4-9 digits).

Recurring PIN Code allows you to set a PIN Code that only works on certain times and days. Either set the PIN Code to work one day a week, daily, weekdays or weekends -during set hours. The app also allows for one-timed and timed PIN Codes.

Using your Pin Code: enter your pin code followed by "✓" to unlock your E-LOK.

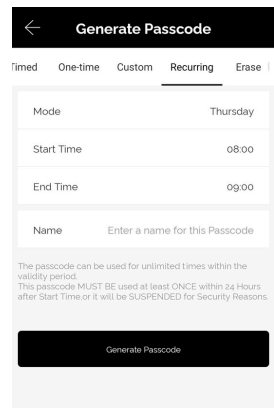
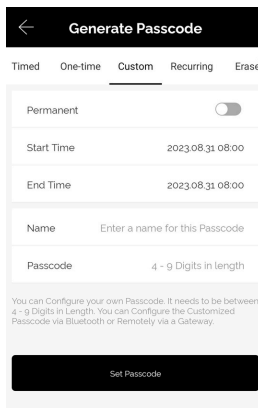
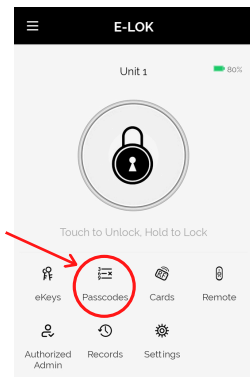

RFID Card Management+ Vague Code

RFID Card Management:

E-LOK App allows you to store 200 unique RFID Cards. To set up one of the three included with your E-LOK 6-Series Smart Lock, tap "Cards" on the lock management page, tap Add Card. Choose Timed, Permanent, or Recurring, and name them individually and add them to your key-ring for easy usability.

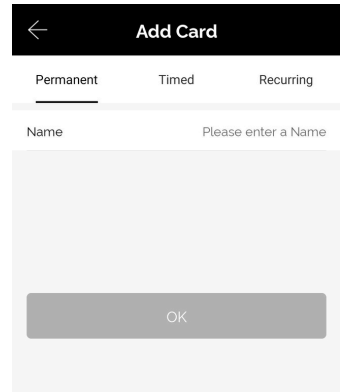
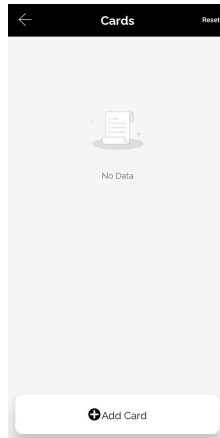
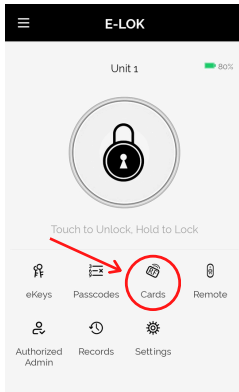

E-LOK Vague Code:

E-LOK's allow you to enter a scramble code, or vague code, of up to 16 digits. For example, if the PIN-Code was 3579, 9287**3579**1122 could be entered and the E-LOK would unlock. The reason this works, is because it still includes the actual PIN-Code somewhere in the sequence. Use this if you want to make it harder for any prying eyes to figure out your PIN-Code!

Remote Unlock + e-Key Management

Remote Wi-Fi Unlock (only with E-LOK Gateway Add-on).

After you've connected your phone to your E-LOK Smart Lock and connected your E-LOK Gateway, open the lock management page and ensure Unlock Remotely is enabled in the settings. Now tap the Unlock icon. This will unlock your E-LOK via Wi-Fi. If Auto Lock is on in the E-LOK settings, it will lock automatically. Otherwise you can hold down the lock button to lock it remotely

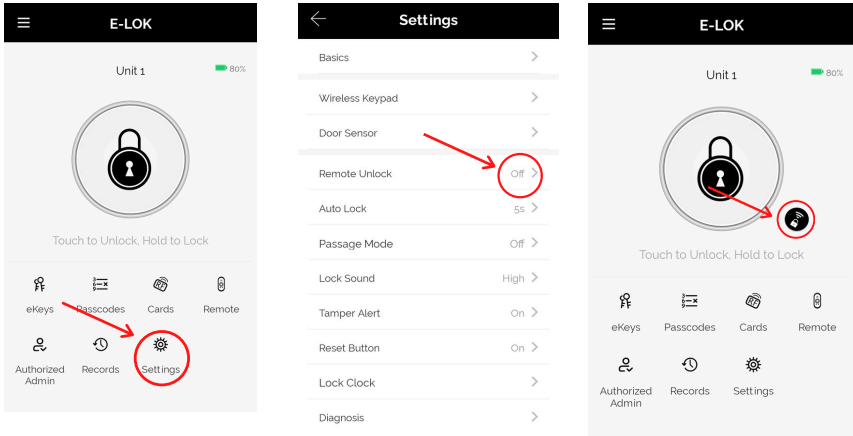

e-Key Management:

An e-Key gives another person with an E-LOK App Account access to view and use your E-LOK 6-Series. Tap on the "eKeys" icon on the lock management page. This allows you to send an electronic key to another person with an E-LOK App account. You can either set the account to be an Admin or a User. If you want them to be an Authorized Admin, click "Authorized Admin" in the E-LOK management home page. Then click "create admin", or, if it is a user eKey, click "send eKey".

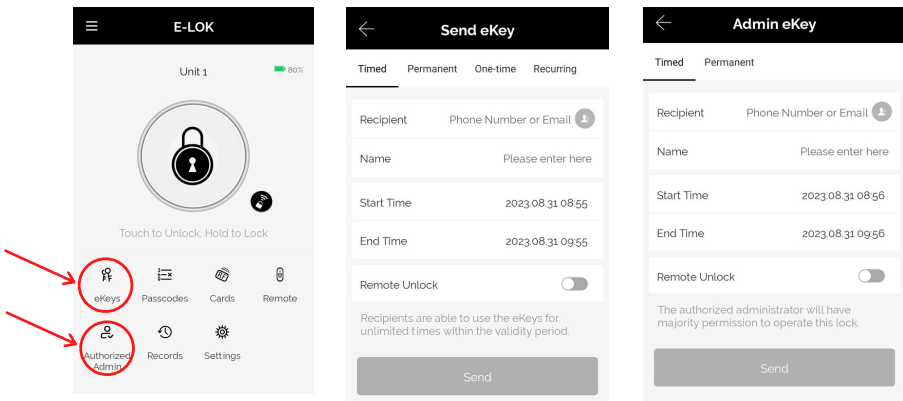

Admin Passcode + Unlock Records

Admin Passcode:

E-LOK comes with an admin passcode. To view this tap "Settings" on the lock management page, tap "Basics" and then tap "Admin Passcode".

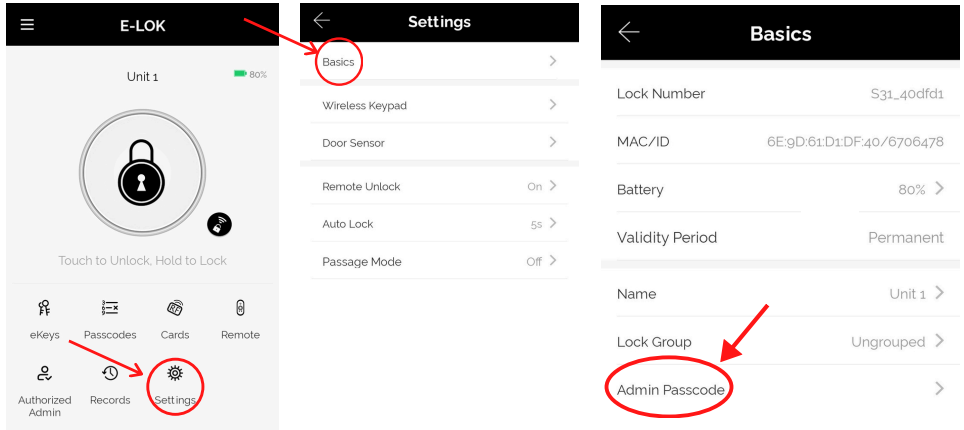

Unlock Records:

E-LOK App records which passcodes were used to unlock the E-LOK and when. You can view these records by going into the "Records" menu on the lock management page. You can see the name of the unlock code, eg "John", what time it was used and what type of unlock code was used. With App versions 1.2 and above, you can view failed unlock attempts and see which code was used.

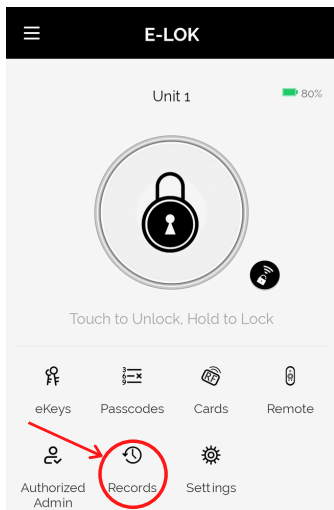

Battery Percentage + Lockset Clock:

Check Battery Percentage:

E-LOK App allows you to check the battery percentage of your E-LOK in two easy ways. In the lock select page, the app will give you a percentage overview to the nearest 5%. You can also find a more accurate battery level in the settings of the Smart Lock. Tap into "Settings", then "Basics" and then view your battery percentage.

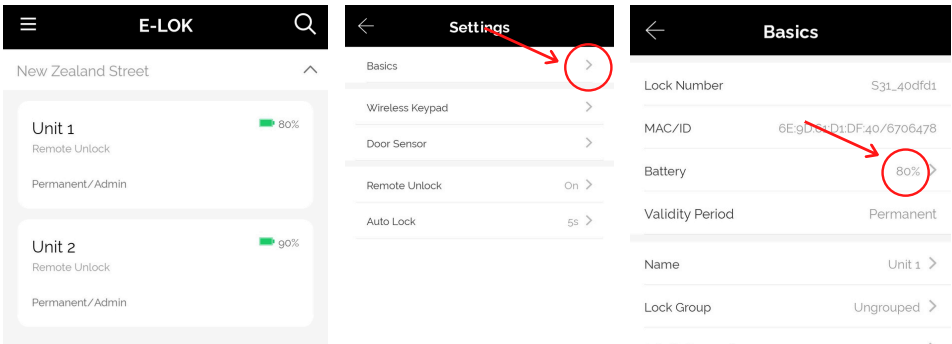

E-LOK Lockset Clock:

For the unlock records to be synced correctly, the Lockset clock needs to be calibrated. To do this, Tap into "Settings" then "Lock Clock". Here tap "Calibrate Time". Your E-LOK Smart Lock will communicate with the E-LOK App and set the correct time. This will ensure the operation/unlock records are accurate.

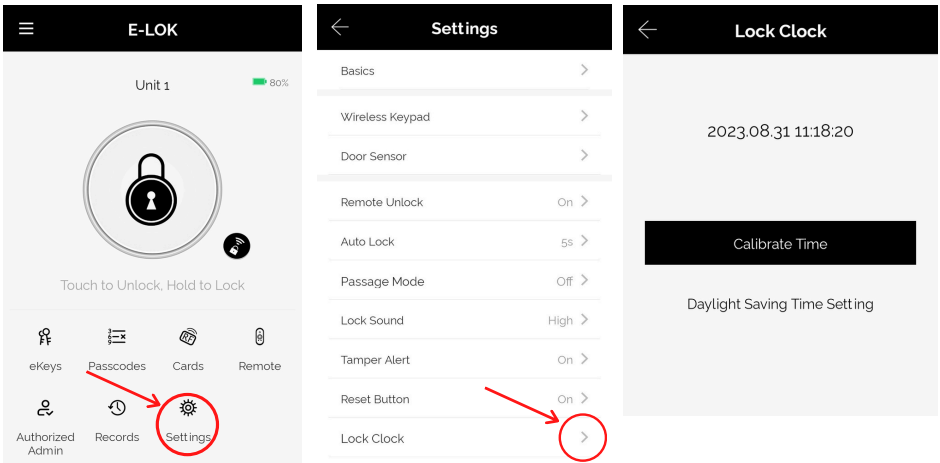

Passage Mode:

Passage Mode:

E-LOK App allows you to manage and control passage mode on your E-LOK 6-Series Smart Lock. Tap into "Settings", "Passage Mode", then choose the days and hours you want your E-LOK Smart Lock to be in passage mode. A common application for this is having a Smart Lock on passage mode Mon-Fri 9am-5pm for an office building. As a security feature, passage mode only begins after an unlock method (pincode, RFID Card etc) has been used on the Smart Lock.

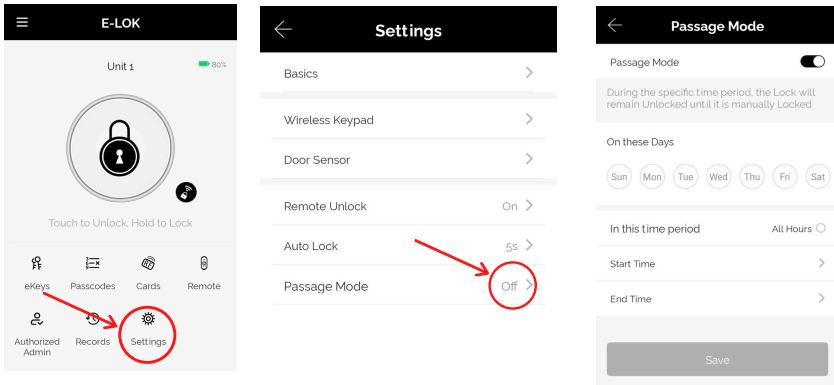

When you leave your house or office with passage mode set on, below are two methods to lock your E-LOK Smart Lock correctly:

Open up the E-LOK App, long press "Lock" button on E-LOK app. This will Lock your Smart Lock until you unlock it with pinpad, fingerprint, RFID Card Etc.

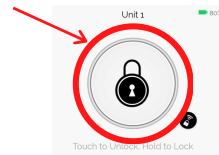

Once exited, long press "TICK" Key on pinpad. This will lock the E-LOK Smart Lock until you unlock it again. This method is perfect as it doesn't require the use of a phone.

To unlock the E-LOK Smart Lock again, please use preferred unlock method, eg Pinpad, RFID FOB or App.



Passage Mode + Remote

Manual Passage Mode:

E-LOK's can be put into passage mode manually also, directly from the keypad with no app intervention needed. Simply input your code and click unlock, and before it auto locks again, input "123✓", the lock should now be set to passage mode.

To take it out of passage mode and lock it again, simply choose one of your locking methods to do so. Holding down the "TICK" key is a preferred option.

E-LOK Remote:

E-LOK's have a function where you can connect a remote to the lock, so you can unlock and lock it via bluetooth.

First, go to Remote, on the E-LOK management page. Next choose permanent, timed, or recurring. Then, click add remote. Follow the instructions on the screen to add the remote to your E-LOK.

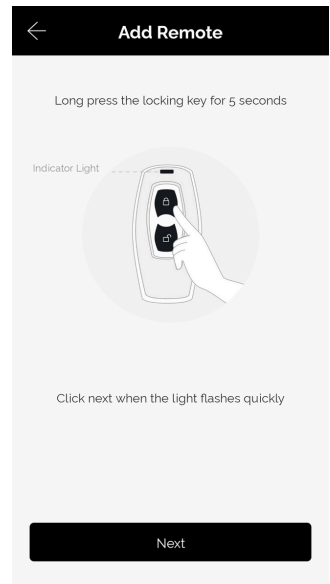
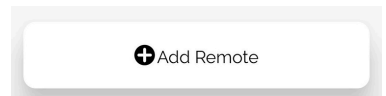
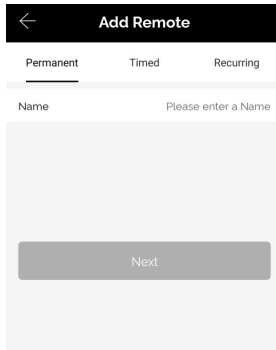
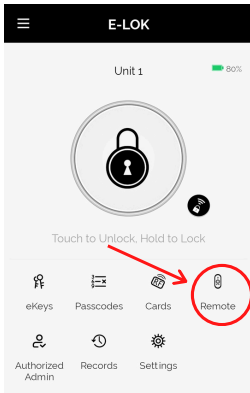

Extra Smart Lock Settings:

Auto Lock:

E-LOK App allows you to adjust the auto lock timer on the Smart Lock. This is the timer that is triggered once the Smart Lock has been unlocked using any unlock method (exception, is if passage mode is enabled). Auto lock timer is under the lock settings tab.

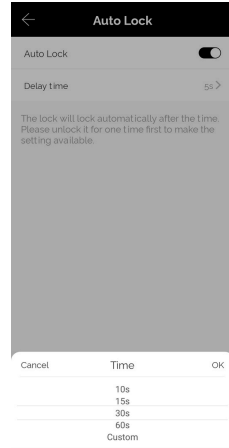
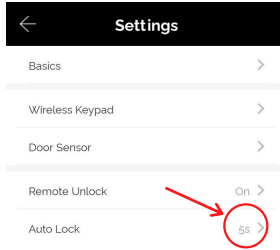
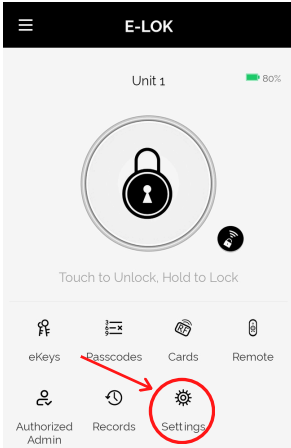

Lock Sound:

Lock sound setting lets you enable, disable, or choose the level of sound coming from the smart lock when you, unlock, lock, set passage mode etc. By default lock sound is set to on.

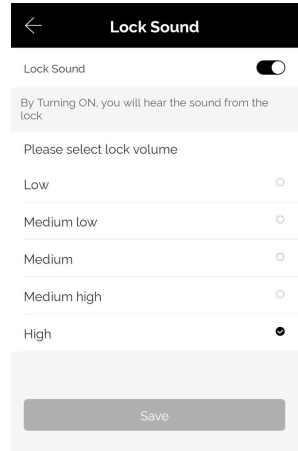
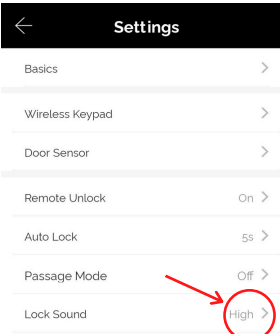
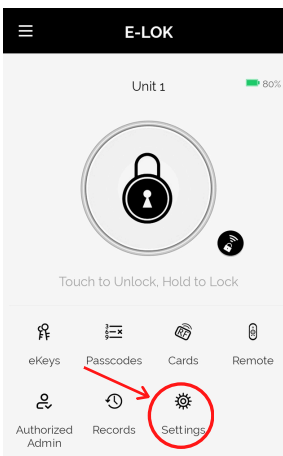

Extra Smart Lock Settings:

Reset Button:

With E-LOK App, you can enable or disable the factory reset button inside the battery case. Disabling this reset button will prevent someone from resetting the E-LOK Smart Lock and locking you out (apart from mechanical key). This feature works great on E-LOK's installed on Airbnb's, rentals etc.

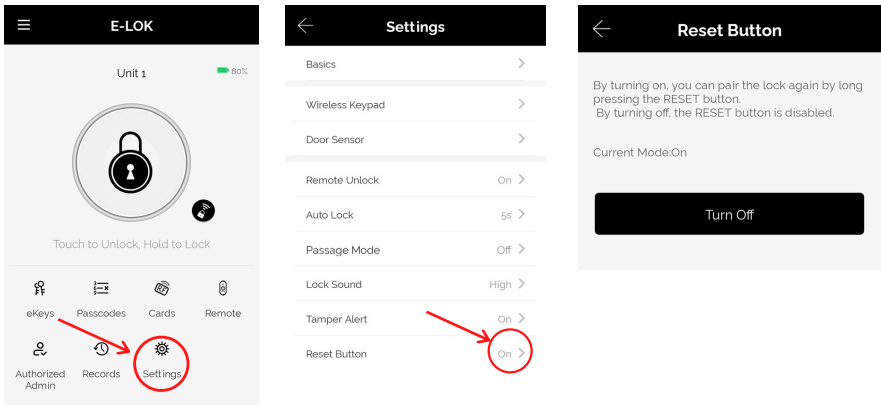

Import from another Smart Lock:

Import from another lock feature allows you to sync PIN Codes and RFID Cards between E-LOK Smart locks. If you have more than one E-LOK Smart Lock, use this feature to have your PIN Codes and RFID Card to work on each, without having to set them up again. This feature is in the lock settings.

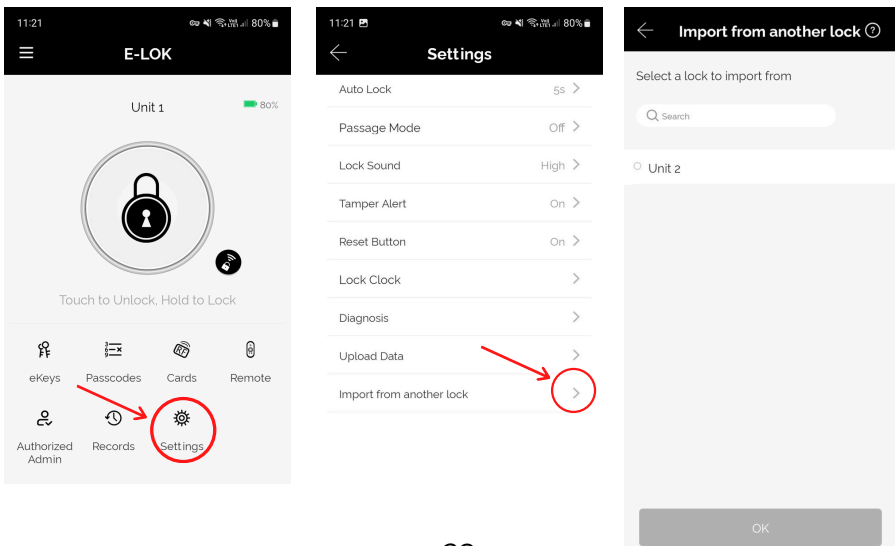

Extra Smart Lock settings:

Lock Groups:

You can link E-LOK Smart Locks together in lock groups. First create a lock group in the main settings, then link a Smart Lock to the group in each individual lock settings, via Settings - Basics - Lock Group. View lock groups in the select page. This function can be used when you have multiple businesses with E-LOK's on each site.

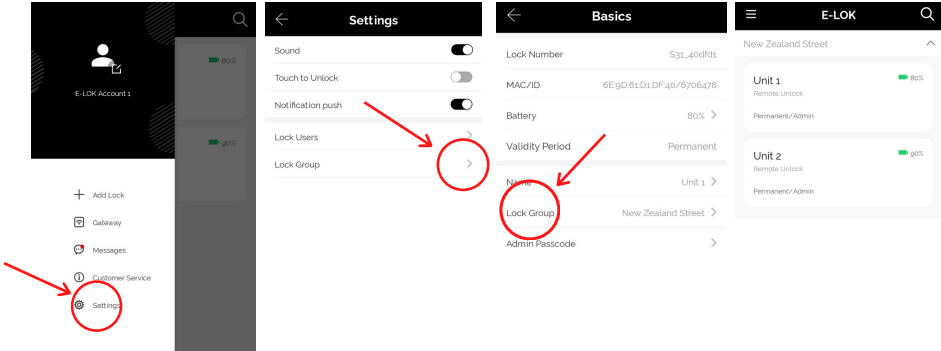

Proximity Touch to unlock:

Proximity touch to unlock when enabled lets you unlock your E-LOK Smart Lock just by pressing any number on the Keypad whilst the app is open. To use this feature, enable "Touch to Unlock" in the settings tab, have your app open to your E-LOK, then press any number on the Keypad.

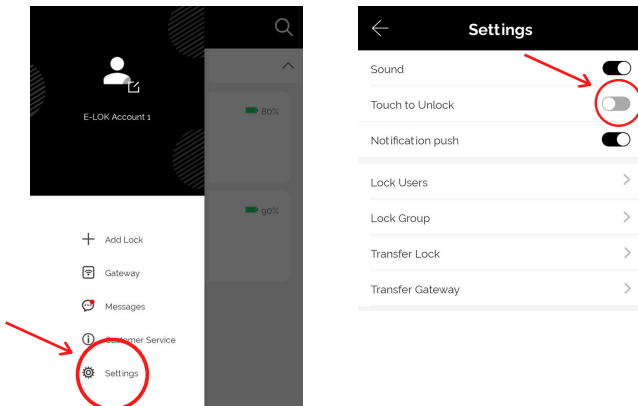

Transfer Lockset Ownership:

Transferring Lockset ownership can be useful in a few scenarios. What it allows you to do is give Master Admin ownership to another E-LOK App account holder. The process to Transfer Lockset Ownership is shown below:

Tap into "Settings" then into "Transfer Lock(s)". Here you can select the Smart Lock you wish to transfer ownership. You will then be required to input the receiving account's email or phone number (whichever the E-LOK App account was created with). The Smart Lock ownership will be transferred to that account.

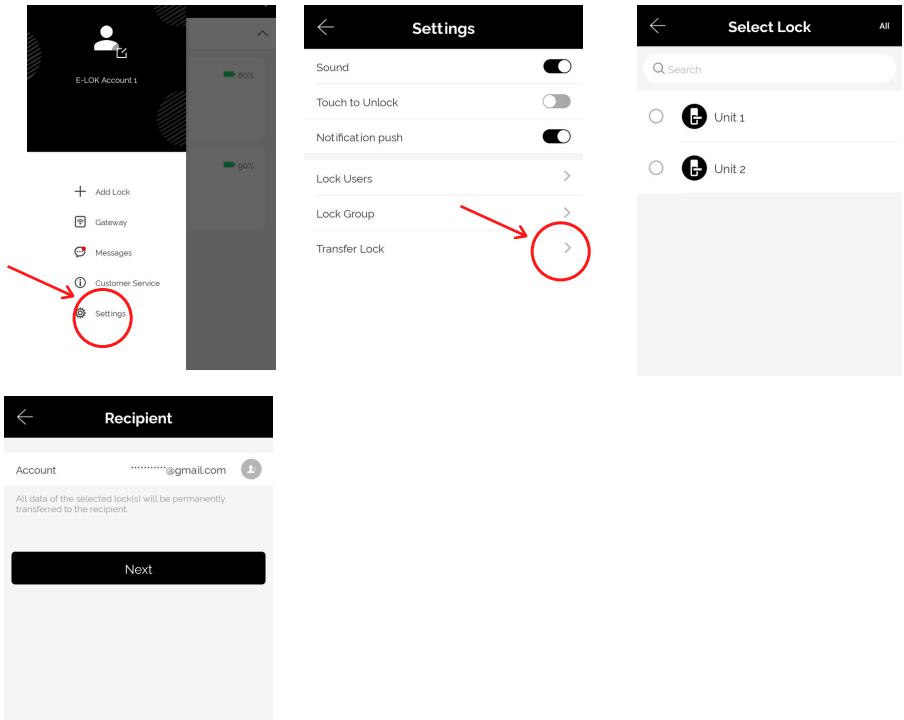

NOTE:

Transferring Lockset Ownership retains any and all PIN Codes, RFID Cards and settings previously programmed to that specific E-LOK Smart Lock.

Unlocking E-LOK 6-Series with Key

The 6-Series Smart Lock has a mechanical key override to unlock it. Barrel location is on the lever like a normal standard key Leverset. Insert one of the included keys, turn and pull handle down to unlock.



Shown above is the location of the mechanical key barrel,

The USB C port underneath the E-LOK can be used to power up the Smart Lock if the batteries fail. When connected to a power bank or battery source, the Smart Lock can be powered up and then a PIN Code, RFID Card or the app can be used to unlock it.

E-LOK Gateway (only if you've purchased the E-LOK Gateway Add-On)

E-LOK Gateway allows you to transfer information and commands to your 6-Series E-LOK via Wi-Fi. It also allows you to change settings, unlock the 6-Series and receive live notifications when it is unlocked and which passcode was used.

Please note: only the **Master Admin** can set-up a functioning E-LOK Gateway for a Smart Lock.

E-LOK Gateway should be plugged in via the included USB-C cable.

It must be:

- Near a Wi-Fi router
- Near the E-LOK 6-Series

If the E-LOK Gateway is not near one or both, connection may be poor and the E-LOK Gateway may not function as expected.

To add the E-LOK Gateway to the E-LOK App follows these steps:

Open the left menu on the E-LOK App. Tap "Gateway". Tap "+" Sign. Select "G2"

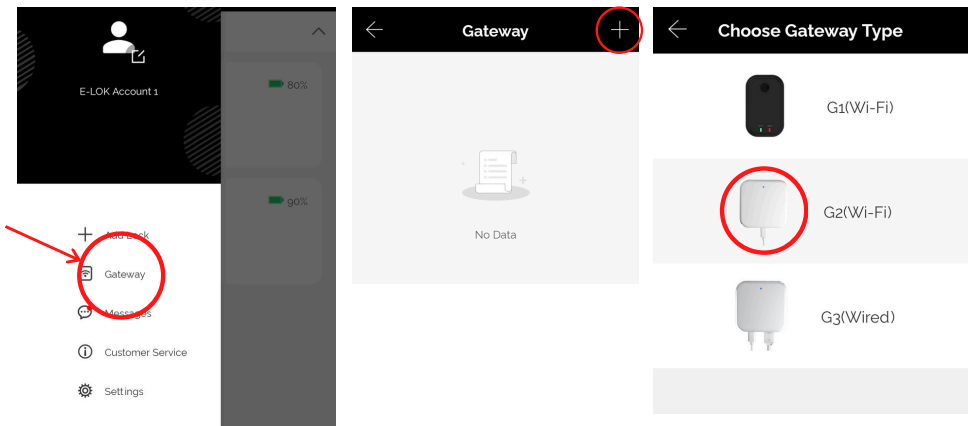

E-LOK Gateway (only if you've purchased the E-LOK Gateway Add-On)

Plug in E-LOK Gateway. Light should flash red and blue - this means it's ready to connect.

Tap "Next" then Tap "G2"

Configure your network (2.4GHz only), input Wi-Fi password and name the E-LOK Gateway.

This will have your E-LOK Gateway set-up on your home network and linked into the app and your 6-Series Lock.

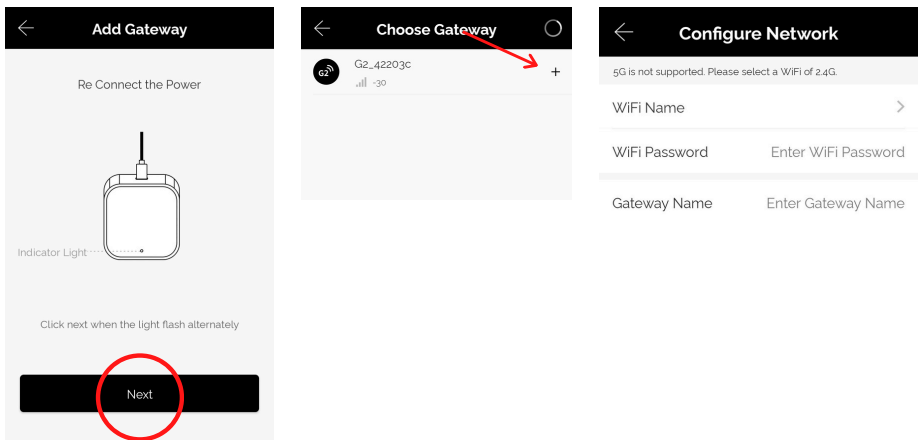

The E-LOK Gateway will now scan for an E-LOK 6-Series to connect to. You can have multiple E-LOK's connected to one E-LOK Gateway. To see what locks are near your gateway, go to Gateway, Tap the connected Gateway of your choice, Tap Nearby Locks.



E-LOK Gateway (only if you've purchased the E-LOK Gateway Add-On)

Last step is to ensure the Unlock Remotely feature is enable on your 6-Series. Open your lock management, tap into "Settings", locate the "Remote Unlock" menu and ensure this is enabled.

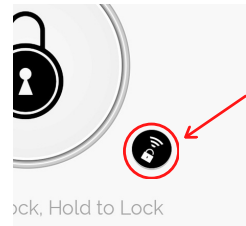
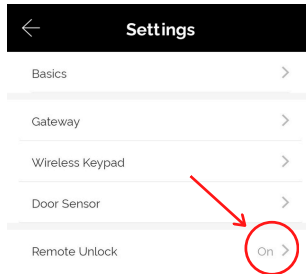
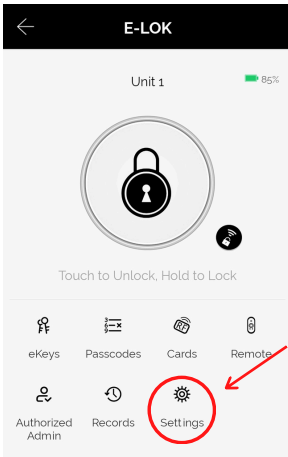

You will now be able to control your E-LOK 6-Series from the app remotely via Wi-Fi, whether you're at work or out-of-town. You can add, change or delete unlock codes. The remote unlock feature will now be available. You can also receive live notifications for when your E-LOK 6-Series was unlocked, and which code was used to unlock it.

If the E-LOK Gateway refuses to connect or displays error messages; disconnect it from the power source for at least 15 minutes. Then retry setting it up.

E-LOK Gateway Specs + other info

Reset E-LOK Gateway:

If you require to factory reset of your E-LOK Gateway follow the below process. Removing the Gateway from your app will unlink the Smart Locks that are connected to it. The Smart Locks will work as usual via Bluetooth.

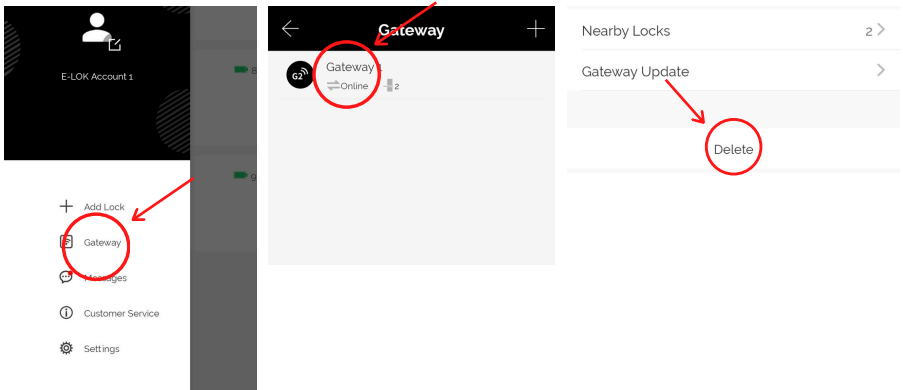

Transfer Gateway:

Similar to transferring Lockset ownership, you can transfer the ownership of Gateway's setup on your account, to another E-LOK account. Steps below show process. Once transferred, you will no longer have access to that Gateway.

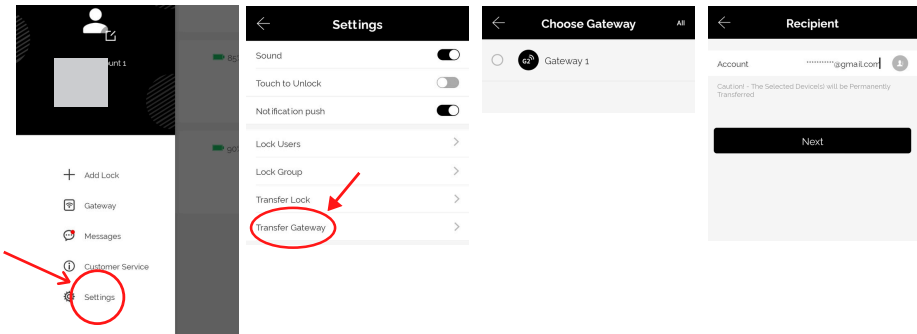

Additional Gateway Specs:

Network: 2.4 GHz

IEEE Standard: 802.11b/g/n

Power Interface: Type-C USB

Power Input: DC5V/500mA

Maintenance Guide:

Maintenance should be carried out on your E-LOK 6-Series every 6 months.

Use the below guide to ensure your E-LOK Smart Lock lasts the test of time:

Every 6 months:

- Check that the screws fixing the mortice lock are tight. Check that the screws fixing the rear panel to the front panel are tight.
- Check if batteries need replacing. If battery percentage is low replace with four fresh Alkaline 1.5V AA batteries. When replacing the batteries, they are located on the inside, under the plastic cover. You slide the whole plastic cover up off the interior side to access the batteries. See below the ways the batteries need to be put in.



- Wipe the surface of the E-LOK 6-Series Smart Lock with a cloth dampened with only water. This will help remove any dust or micro contaminants from the surface.
- It is also a good idea to do a full Manual Factory Reset of the E-LOK 6-Series Smart Lock to ensure software stays light and un-bloated.

Important Notes:

Please Note:

You must use the E-LOK App to set-up your E-LOK 6-Series Smart Lock and get full functionality of it. When you first plug in your 6-Series, the Smart Lock will have very limited features until you have completed the short set-up process and added at least one unlock code. You can find a link to the app on E-LOK.com

The E-LOK App allows you to manage an unlimited amount of E-LOK 6-Series Smart Locks from your phone. Remember to name each E-LOK 6-Series Smart Lock uniquely to ensure you don't mix them up.

The E-LOK Gateway can connect to multiple E-LOK 6-Series Smart Locks. An instance where you'd need multiple E-LOK Gateway's is if one E-LOK 6-Series Smart Lock is on a different site or only in range of a different Wi-Fi network.

The E-LOK App allows you to manage multiple E-LOK Gateways with their individually connected E-LOK 6-Series Smart Locks. This means you can have an E-LOK Gateway at home connected to your E-LOK 6-Series Smart Lock plus one at work and manage them individually.

E-LOK App works with E-LOK 5,6,7, 8 & 9-Series Smart locks. You can have all Series linked to your app at the same time.

Contact:

If you run into trouble with your E-LOK 6-Series Smart lock please visit: E-LOK.com for further information, help and tools. If you don't find your answer on E-LOK.com use the contact box and send us an email.

You can also email us direct, by going into the Customer Service menu on the E-LOK App.

Notes:

Notes:

ELOK

6 - Series

User Manual

E-LOK.com

Version: 2408 E6UM